

LED panel must be mounted onto a heatsink with suitable heat transfer material/paste

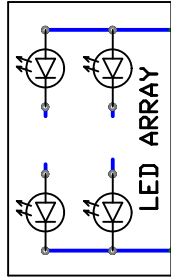

C21/C2
LIMIT PEAK CURRENT
KEEP <5A

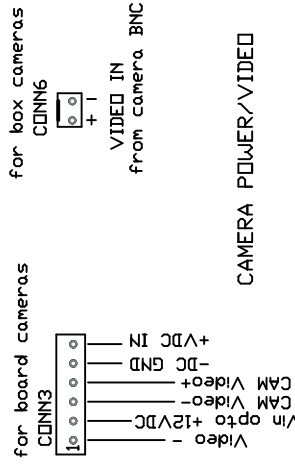
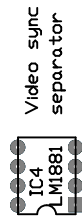
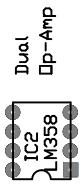
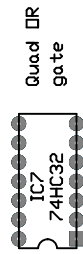
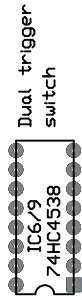

MUST HAVE POWER TO CONN3 PIN2 connect to TP2 or other 12V power

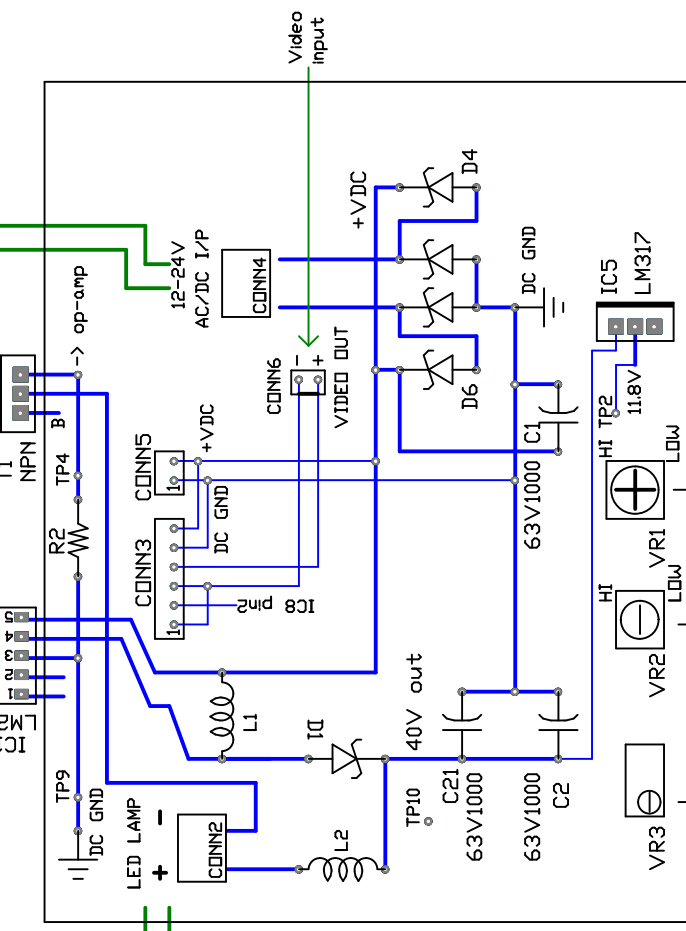
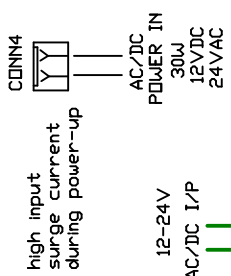

LED pulse phase delay optimized for 1/1000s shutter (1.2ms on time TP10 measure)

LED out brightness 1/1000s shutter (1.2ms on time TP10 measure)

LED peak power adjust

