

PMSC36 Series Occupancy PIR Motion Sensor Auto Switch Ceiling Mount



Applications:

- Intermittent use areas
- Private offices
- Storage rooms
- Restrooms
- Study rooms
- Show rooms
- Conference rooms
- Display areas
- Warehouses
- Library aisles
- Walkways
- Lobbies

Features:

- Long life, low maintenance
- SMD technology design
- Automatic operation
- Integrated PIR sensor unit
- Relay output
- 3 dual-element PIR sensors
- 360° coverage
- Adjustable ON-Time
- Adjustable daylight mode
- Adjustable sensitivity
- Always-ON function
- CE, GS, RoHS, UR

Onstate passive infrared (PIR) occupancy motion sensors automatically shut off power to lights when the room is not occupied to provide energy savings. It could be used to meet local energy use standards and requirements. The PMSC36 uses three high sensitivity sensors and a multi-level, high-density Fresnel lens to provide overlapping 360° coverage while reducing no-sensing zones for reliable, consistent operation. It features relay output, adjustable delay time, adjustable sensitivity and daylight OFF level to suit multiple applications. The PMSC36 triggers the relay to turn on the lights once motion is detected and will reset the ON-time every time it detects motion for continuous operation. Onstate occupancy motions sensors have a short payback period (less than a year) and provide long-term energy savings.

Specifications:

Power: 120 (4W)/240 (7W), 50-60Hz,
24VDC (14-17VAC) 1W Max.
Load Control: Relay (NO), works with inductive loads.
800W@120V, 1200W@240V, 10A@24V.
Daylight ON mode: Adjustable, <3Lux to daylight
ON-Time: Adjustable, Min: 8 seconds. Max: 8 minutes
Sensitivity: Adjustable, min-max
Detection: up to 40ft radius (12m), 360 degrees
Temperature: -10°C to +40°C
Installation Height: PMSC36: 5-12ft (1.5-3.6m)
PMSC36H: 12'-20' (3.6-6m)
Environment: Dry, non-condensing location
Status Indicator: Green LED, flashing activity
Dimension: 4.65" (D) x 2.25" (H)
Weight: 0.5lb (220g)
Mounting: Ceiling mount, electrical box
Standards: CE, RoHS, UR
Wiring: 3 wires (120/240V), 4 wires (24V)
Warranty: 2 years



Three PIR sensors



Relay output

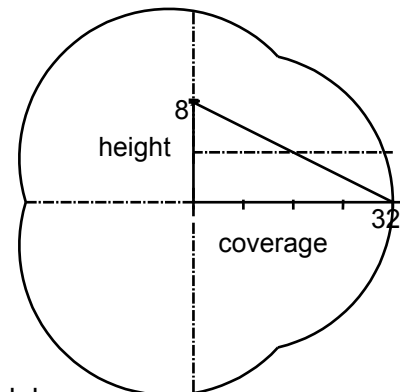

Part Coding: PMSC36x-y, PMSC36Hx-y for high ceiling model.

x= voltage. S=120VAC(standard), E=240VAC(Europe), L=24VDC (low voltage)
24V model can be used with Leviton occupancy sensor power packs. Also works for
24V LED lights for automatic control. Other low voltage models available.
y=options. 1=Standard (Automatic/Always-ON function).
2=AUTO (Automatic/Always-ON function disabled).

PMSC36 Motion Sensor Functions:

Function:	Description
Daylight mode light level (<i>PHOTO</i>)	The <i>PHOTO</i> function sets the light level for daylight mode. The relay will stay off in daylight mode. The PIR unit will operate normally again once the ambient light level is below the light level setting. Counter-clockwise direction (moon side) will decrease the light level for daylight mode. Clockwise direction (sun side) will require brighter light for daylight mode. If the adjustment is full clockwise (sun side), the PIR unit will always be on auto mode. Adjustment range: <3Lux to daylight.
ON-Time (<i>TIME</i>)	Once motion is detected, the output relay turns on and the delay off timer starts. If there is no motion detected within the preset delay time, the timer will not reset and the relay will turn off the lights. The timer will reset with detected motion for continuous on-time. Rotate the <i>TIME</i> adjustment counter-clockwise (- side) will decrease delay time. Clockwise direction (+ side) will increase delay time. Min: 8sec. Max: 11min.
Sensor sensitivity (<i>SENS</i>)	The <i>SENS</i> function sets the sensitivity of the PIR unit to sense motion. Rotate the <i>SENS</i> adjustment counter-clockwise (- side) will decrease overall sensitivity and decrease detection range. Clockwise direction (+ side) will increase sensitivity and detection range.
Always-ON / Auto-Mode	This function will force the PIR unit relay to stay on regardless of motion detection. To activate the Always-ON function, shut power off for ~2 seconds then turn power back on. The PIR unit will resume automatic operation if the power is off for more than 12 seconds then on again. The Auto-Mode (Automatic, Always-ON function disabled) option prevents the lights from being locked-on due to accidentally power on/off cycling. This mode is suitable for use where the main light switch maybe intermittently switched on/off.
LED activity	Power and activity status indicator. The LED will flash once every 4s during warm-up. It will flash two times per second when there is motion detected. If the Always-ON mode is on, it will continuously flash once per second.

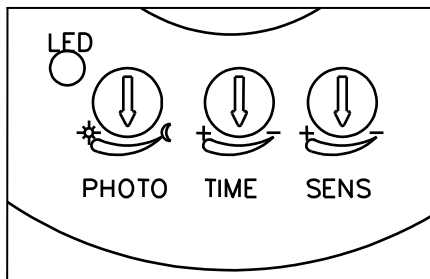

PIR motion sensor adjustment controls.

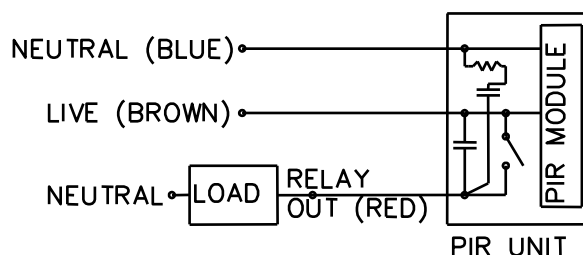

Standard 120/240V wiring

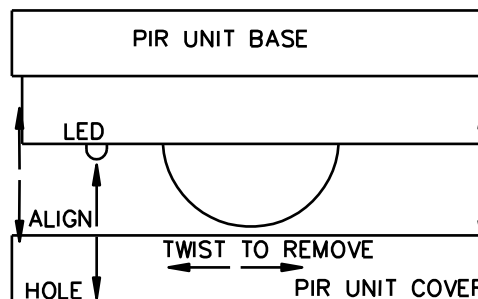

Installation Instructions

CAUTION
ELECTRIC SHOCK HAZARD.
USE PROPER SAFETY PRECAUTIONS.

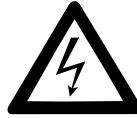

Please carefully read through the installation instructions prior to installation.

NOTES:

1. Should be installed by qualified personnel.
2. Follow applicable local electrical codes.
3. DO NOT install near fans, HVAC air vents, or transient warm/cold objects or sources.

Parts included:

- 1x Occupancy PIR motion sensor
- 1x masking sticker, label
- mounting screws/hardware

Parts required:

- 1x single-gang or ceiling electrical box
- 1x electrical box cover W/knock-out or adaptor bracket/plate (optional)
- tools and general electrical hardware

1. Determine mounting location on ceiling. The PIR sensor can only sense direct light-of-sight.
2. Shut off power source. Install power cable to mounting location.
3. An electrical box may be required to meet local electrical codes. Install and wire.
4. Remove cover on PIR unit. Twist and pull.
5. The mounting hole spacing on the PIR unit base is ~3.28" (single-gang box spacing). If using a ceiling or similar electrical box, an adaptor plate is required (different mounting hole spacing). Put PIR unit on mounting plate and mark off mounting hole locations (~3.28"). Drill and/or thread for mounting screws (6-32). Cover knock-out hole with suitable wire protection.
6. Insert PIR unit wires into electrical box. Connect power live to PIR unit live (brown) with twist caps. Connect power neutral to PIR unit neutral (blue) and load neutral. Connect relay out (red) to load live. See wiring diagram below. 24VDC is blue/blue power input and brown/red relay out control.
7. Mount PIR sensor unit. Rotate PIR unit for best sensing location.
8. Apply power. Test and adjust PIR adjustments. Insert PIR cover plate onto PIR unit. Make sure that the activity LED is aligned with the cover hole. Apply masking sticker if necessary to block sensing area.

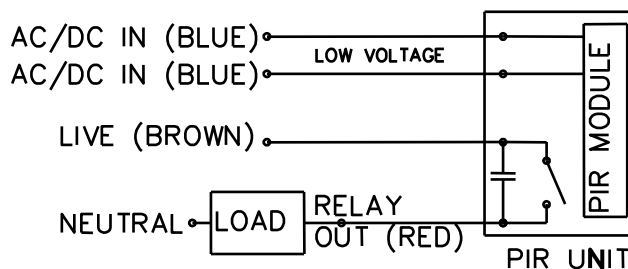
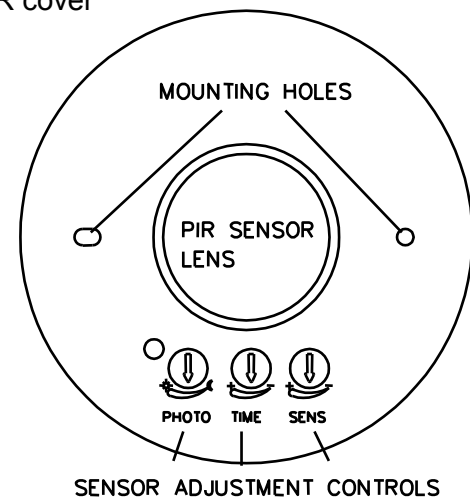
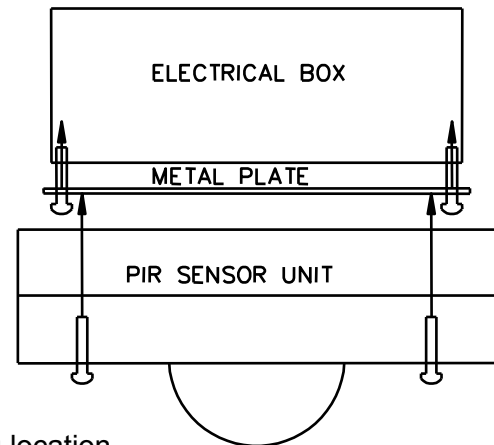

24V wiring: AC/DC IN, AC/DC IN, Relay In, Relay Out.
 (120/240V PIR unit wiring: Live, Neutral, Relay Out.)

Testing:

1. Rotate the *TIME* adjustment to full counter-clockwise (- side).
2. Rotate the *PHOTO* adjustment to full clockwise (sun side).
3. Apply power to PIR unit. The LED will flash and the relay will not turn until 10s later. After a warm-up delay of 60s, the lights should be off.
4. Move within the sensor range for activation then move away. The lights should turn on and off within 15s. The LED should flash to indicate motion. Adjust the sensitivity (*SENS*) to set the desired detection range. Use the white sticker provided for area masking. Slowly rotate the *TIME* adjustment clockwise for the desired ON-time. Rotate the *PHOTO* adjustment for daylight mode light level setting. A 1/8 turn from full clockwise (sun side) sets the light level for a lobby to maintain average lighting levels.

Trouble Shooting:

Load does not turn on:

1. If the relay clicks on and makes a sound, check load wiring and load.
2. Check if LED flashes. If it does not detect motion or flashes at close range, check power and wiring.
3. If LED flashes and the relay is off, check *PHOTO* adjustment. Re-adjust if necessary.
4. If the PIR unit operates normally and the load (light) is functioning, the relay or relay wiring may be damaged. The PIR unit may require servicing. Please contact Onstate Technologies.

Low sensitivity to movement:

1. Increase PIR sensitivity (*SENS*).
2. Check for objects blocking the detection area.
3. Motion detection is highest when the person is moving perpendicular from the sensor. Sensitivity is lower when the person is moving directly towards the sensor. Rotate PIR unit slightly to change detection angle.
4. A high ambient temperature decrease sensitivity. Reduce ambient temperature if possible.
5. The mounting height affects detection area. Increase height if necessary.

Load does not shut off:

1. Check wiring.
2. Check if the LED flashes. It may detect motion from objects or other heat sources.
3. Check On-Time. It may be set for long delay.
4. If the relay does not shut off after extended no motion detected, the Always-ON function may be activated. Shut off power for more than 12s to reset the PIR unit.
5. If the PIR unit is operating normally and the load still does not turn off, the relay or electronics may be damaged. The PIR unit may require servicing. Please contact Onstate Technologies

Warranty:

Onstate Technologies warrants its products to be free of defects in materials and workmanship for a period of two (2) years. All products are sold as-is. Onstate technologies assumes no liabilities or obligations due to consequential damages caused by the product directly or indirectly with respect to loss of property, revenue, or cost of removal, installation or reinstallation. Modifications or improper use will void warranty.

Thank you for choosing Onstate Technologies