

The BP Battery Protector is a multi-function low-voltage disconnect and battery monitoring unit. It automatically shuts off the power to a load when the power source voltage is below a preset level. The module also monitors the battery voltage by flashing the LED at a preset level and will flash faster as the voltage decreases. The flashing LED feature gives notice to safely shutoff the equipment. The BP unit is suitable for unmonitored battery protection for marine, industrial or recreational use applications. The adjustable trigger voltage settings allow for custom battery protection levels to maintain safe loading. Simply connect the Battery Protector inline with the load for power protection.

Features:

- Adjustable low and high voltage shut-off.
- Flashing LED status/level indication.
- Input polarity protected.
- Easy to use. Simple wiring.
- Automatic operation. Auto shut-off and reset.
- Surge delay sensing.
- Basic to full-function versions available
- Electronic fuse option available
- Malfunctioning charger LED indicator option

Benefits:

- Extends battery lifespan.
- Prevents over discharged batteries.
- Prevents low and high voltage to equipment.
- Maintain reserve power for emergency use.
- Extends battery lifespan.

Applications:

- Marine, boat, auto, remote field use, others
- Battery and load protection
- Voltage monitoring to equipment.

Operation:

The Battery Protector requires no user intervention or affects the equipment in use during normal operation. The LED will start to flash slowly when the battery is below a preset level. The flashing rate will increase as the voltage decreases. The power output through the MOSFET or relay output will shut off once a preset low voltage level is reached. The LED will flash at a rapid rate to indicate the output is off. The shut off is set so there is enough reserve energy for emergency use or to start the boat/car once. It will stay off until the circuit is manually reset or automatically reset during battery charging. There is an over voltage monitoring option to ensure safe operating voltage to the equipment.

Technical Specifications (12V model)

Standard pre-set settings. Other versions have optional features.

Operating voltage:	10V-16VDC
Low flashing voltage:	12V (adjustable)
Low shut off voltage:	11.2V (adjustable)
Low voltage reset:	12.8V (adjustable optional)
Over voltage shut off:	15.5V (adjustable optional)
Over voltage reset:	1.3-1.5V lower than over-voltage shut-off (fixed hysteresis)
Output current:	7A with N-CH MOSFET, 10A max. peak
Power consumption:	10mA max with LED on.
LED display:	Green (good), flashing (low battery), orange (over-voltage, optional)
Operating temperature:	-35°C to +65°C (-30°F to +150°F)
Surge delay:	~ 10 seconds
Module dimensions:	1.71" square (43.4mm square)
Mounting holes:	1.5" square (38.1mm square), 1/8" holes for M3 or #4 bolts.
Wire lengths:	colour coded

Note: Do not use in wet locations. Do not exceed the specifications of the unit.

Installation:

Please read the appropriate data sheet prior to installation for best results. The installation should be made by a person knowledgeable in the product and conforms to all appropriate local codes. Onstate Technologies Inc. will not be responsible for injuries or damages resulting from the improper installation or use of any products sold by Onstate or its retailers. Install the product within its specification limits.

Wiring:

Simply connect the battery power to the positive (+ Red) and negative (- Black) of the input wires. The Battery Protector unit is polarity protected and will not be damaged from reverse input wiring on the power input. The output control is through an N-CH MOSFET or can be connected to an independent SPDT relay switch. Connect the positive power wire from the battery to the + load of the equipment and -OUT of the battery Protector to the ground of the equipment. The MOSFET wiring method is not for common ground equipment (chassis). The relay wiring method is recommended for grounded equipment. A diode is required on the relay coil or any inductive loads. See figures below for wiring methods.

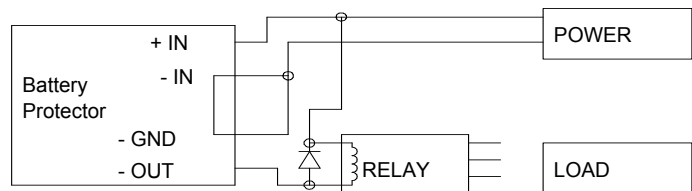
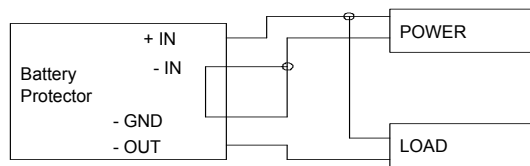

Figure 1. Standard wiring with N-CH MOSFET.

Figure 2. Relay output wiring.

Positive or negative output switching is possible through the relay. Simply connect the power input wire to the “COM” and the output wire to the “NO”.

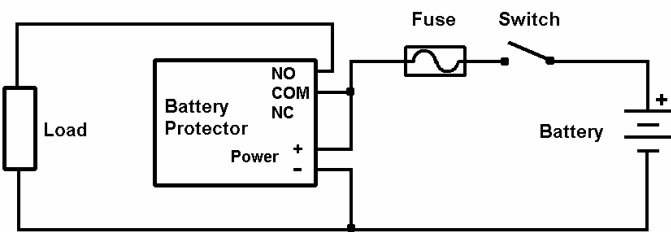

Figure 3. Standard configuration.

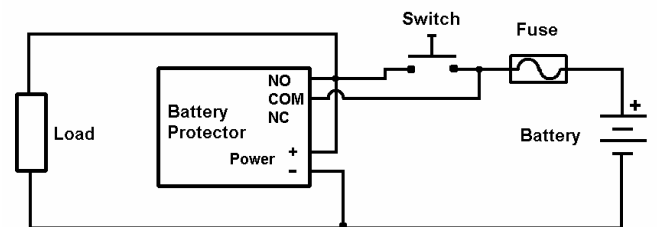

Figure 4. Total shutoff with reset switch.

The Battery Protector will monitor the battery voltage and shuts off the output when the battery is low. There is a small standby current drained from the battery when the output is off. The power switch in series with the power can be switched OFF/ON again to reset the circuit in Figure 3. The unit will also reset when the battery voltage reaches the preset level during charging. Figure 4 wiring is for a total shut off of the Battery Protector once the output is off. There is no standby current drained from the battery once the output is off. The switch is momentarily pressed to start/reset the Battery Protector.

Various versions of the Battery Protector have different options available. The low voltage reset adjustment allows the battery to charge to a higher voltage (higher charge) before the power to the load is reset back on. The over voltage shutoff control limits the voltage to the load to prevent over loading. In cases of malfunctioning charger or bad battery, the voltage to the load is exceeded. The version with a charge indicator has a dual-colour LED that turns on when the input voltage is between the range of over-voltage and low voltage settings including the hysteresis voltage ranges. If the battery charger is operating correctly, the yellow LED will turn on. It will turn off if the battery charger is disconnected. The electronic fuse option version has a current sensing (shunt) feature that shuts off the load power if the current to the load exceeds the set rating. See Table 1 below for list of versions available.

Table 1. List of features of various Battery Protector versions.
12V Models (assemble appropriate parts as necessary)

Part code	adjustable low shutoff	adjustable low flashing	adjustable shutoff reset	adjustable over voltage	MOSFET N-CH output	battery status LED	charging indicator	charging relay
CIR-BMBP-12V-1	x	x			7A	x		
CIR-BMBP-12V-2	x	x	x		7A	x		
CIR-BMBP-12V-3	x	x	x	x	7A	x	x	
CIR-BMBP-12V-4	x	x	x	x	0.3A, relay signal	x	x	1A

Extra modifications and wiring required for -2/3/4 versions.

24V Models

Part code	adjustable low shutoff	adjustable low flashing	adjustable shutoff reset	adjustable over voltage	MOSFET N-CH output	battery status LED	charging indicator
CIR-BMBP-24V-1	x	x	optional		7A	x	

12V Electronic Fuse Model. Re-settable electronic fuse.

Part code	adjustable low shutoff	adjustable low flashing	adjustable shutoff reset	adjustable over voltage	MOSFET N-CH output	battery status LED	trip fuse LED	trip current 0.1 shunt
CIR-BMBPE-12V-1	x	x	optional		7A	x	x	4A

Note: Current surge delay is 5s rather than 10s for standard Battery Protector.

Pictures for illustrative purposes only. Actual unit may differ slightly.

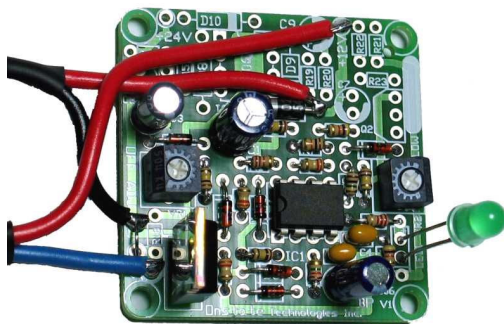

Basic Battery Protector (CIR-BMBP-12V-1)

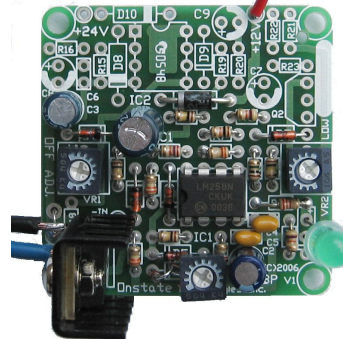
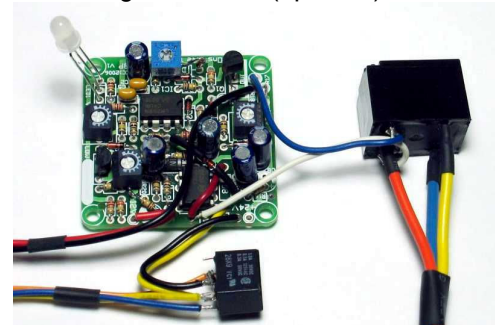
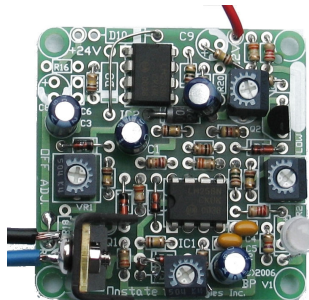
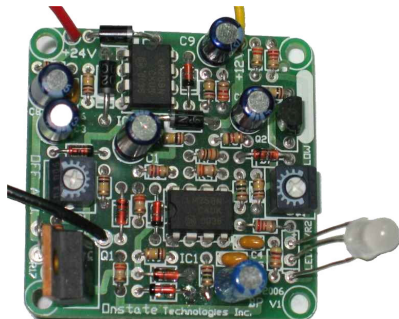
 More function unit (CIR-BMBP-12V-2).
Heatsink added for higher current (optional)

12V electronic fuse CIR-BMBPE-12V-1. 12V full function (-3) and relay version (-4) (power relay optional)

Adjustments and setup:

Standard voltage setting is 11.2V off and 12V LED flashing. A variable voltage power supply, a voltmeter to display the voltage and a small slot screwdriver are required to make adjustments.

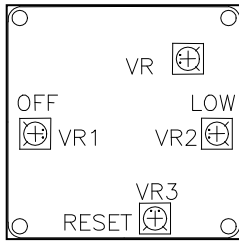

CW- clockwise
CCW- counter-clockwise
VR1-shut off
VR2-low flashing LED
VR3-reset
VR-over voltage shut off

- VR1** Clockwise (CW) to shut off output.
Counter-clockwise (CCW) to turn output on.
- VR2** Clockwise (CW) to shut off low voltage flashing LED.
Counter-clockwise (CCW) to start low voltage flashing LED.
- VR3** Clockwise (CW) to lower reset voltage.
Counter-clockwise (CCW) to increase reset voltage.
- VR** (VR4) CW to shutoff output, lower over voltage setting.
CCW to turn on output, increase over voltage setting.

Setup-Basic Unit:

1. Center VR1 and VR2 adjustments.
2. Set power supply at power shut off voltage (eg. 11.2V) level. Wait 15 seconds for the surge delay to stabilize. The output should be on. The LED should be on and not flashing.
3. Rotate VR1 clockwise slowly until the LED flashes quickly. Increase voltage to reset unit (12.7-12.9V). The LED should be steady again.
4. Set power supply to 12.0V. Rotate VR2 slowly CCW until the LED starts to flash.
5. VR3 adjustments affect VR1 adjustments. VR1 trimming may be required after adjusting VR1.
6. Vary power supply voltage from 14 to 11V to check for proper operation.

Setup-Full:

7. Set power supply at power shut off voltage (eg. 11.2V) level. Wait 15 seconds for the surge delay to stabilize.
8. Rotate VR1 fully counter-clockwise to turn output relay on. Rotate VR2 fully CW shuts off low flashing LED. Rotate VR3 fully counter-clockwise for maximum (high) reset voltage. Set VR fully one direction to set high-voltage shut-off to maximum.
9. Slowly rotate VR1 clockwise until output shuts off.
10. Set power supply to reset voltage (eg. 12.8V). Note: The reset voltage must be within 1.3-2V higher than shut off voltage.
11. Rotate VR3 clockwise until output resets to on.
12. Set power supply to low flashing LED voltage (eg. 12V).
13. Rotate VR2 counter-clockwise unit LED starts flashing to indicate low battery voltage.
14. Set power supply to over-voltage shut-off level (15.5V). Adjust VR for output on. Slowly adjust VR for output off.
15. Vary power supply voltage to confirm settings. Make re-adjustments if necessary.

Battery Protector Design

Battery protector PCB

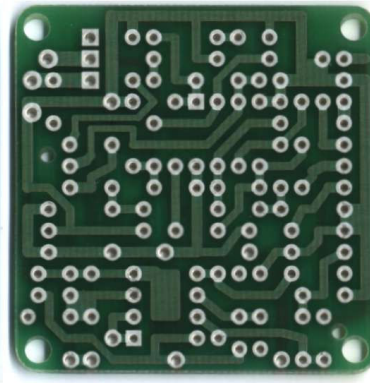
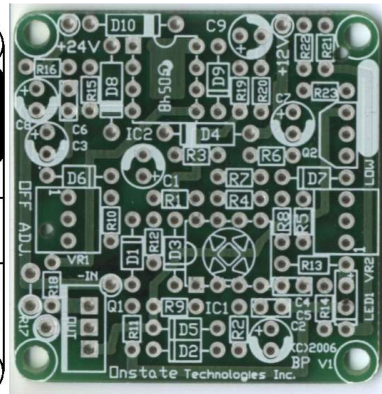
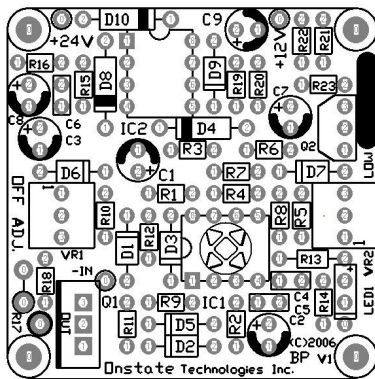

Legend layout on BP PCB.

Top side PCB

Bottom side PCB

Full schematic (CIR-BMBPE-12V-1). All parts are available from Digi-key. All resistors are 1/8W.

